

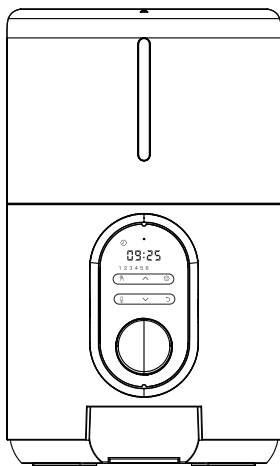

Barn Automatic Pet Feeder

Model: FT50



USER MANUAL

[CONTENTS]

| | |
|---|----|
| Product Specifications | 2 |
| Hardware Installation | 4 |
| Take off the bowl | 4 |
| Remove the lid | 5 |
| Load in desiccant | 5 |
| Install the battery | 6 |
| Insert power cable..... | 6 |
| Install the bowl | 7 |
| Install the food tank | 7 |
| Install the lid | 8 |
| Cleaning the food tank | 9 |
| Cleaning the rotate plant | 10 |
| Panel Introduction | 12 |
| Buttons Overview | 13 |
| Screen Panel Introduction | 14 |
| Setting Guideline | 15 |
| Setting Current Time | 15 |
| Setting Meal | 18 |
| Return to Interface | 20 |
| Locking & Unlocking | 21 |
| Recording | 22 |
| Manual Feed | 22 |
| Feeder Alarm | 23 |
| Reset to Factory Default | 23 |
| FAQs | 24 |
| FCC Warnings | 25 |
| Warranty Information | 27 |
| Have a Question For the Seller | 30 |

Product Specification

| | |
|-----------------------|---------------------------------------|
| Model | FT50 |
| Capacity | 4L |
| Meals | 6 meals per day |
| Screen | LED screen |
| One portion | 12grams (8 portions at most per meal) |
| Food size | 2- 12mm(dry food only) |
| Pet size | Small/medium-sized dogs and cats |
| DC-powered supply | 5V/1A |
| Operating temperature | -10°C - 55°C/14°F-131°F |
| Dementions | 19x19x31.6cm/7.48x7.48x12.44in |
| Product weight | 1.5kg/3.3lb |

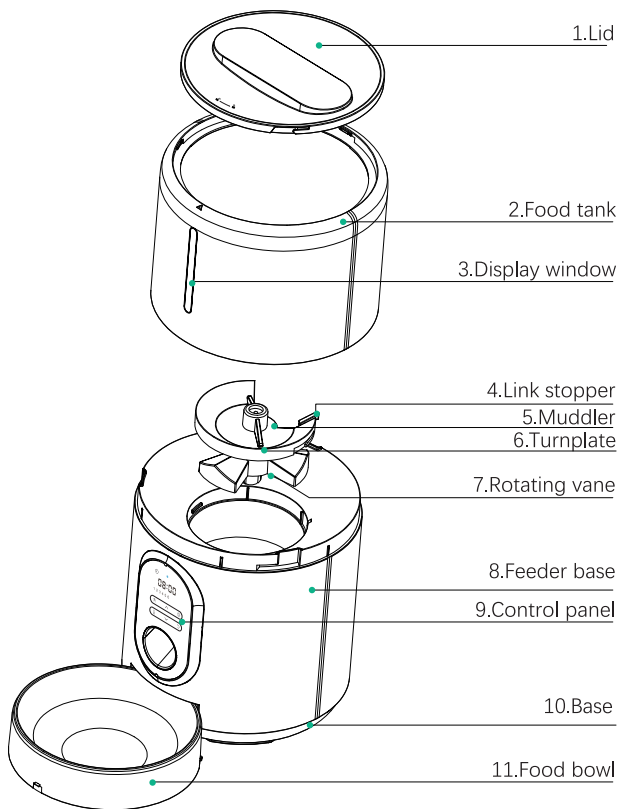

Hardware Installation

1 Take off the bowl

- Rotate the food tank counter-clockwise, and then lift the barrel at the same time, remove the food tank, and take out the Type-C charging line, desiccant, instruction manual, etc.

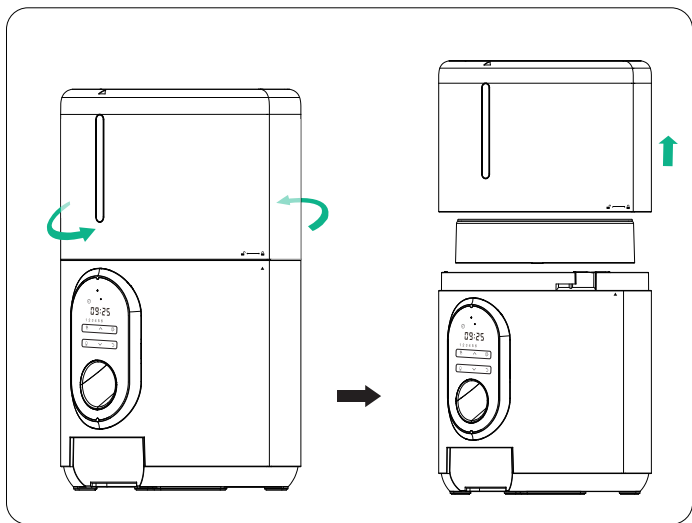

2 Remove the lid

- Turn the lid counterclockwise, lining up the arrows, then lift lid up.

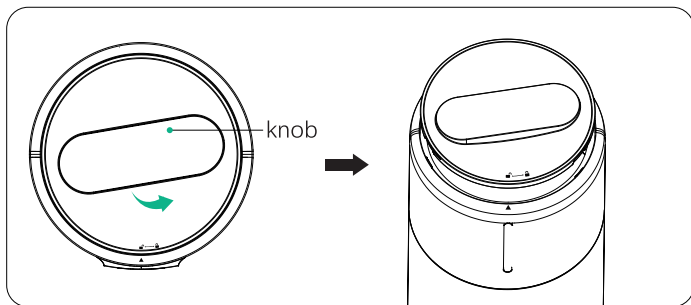

3 Load in desiccant

- Open the desiccant cap, put in the desiccant, and then close.

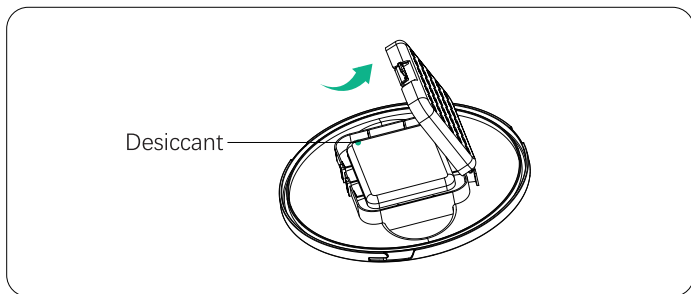

4 Install the battery

- Open the battery cover upward , put in 3 D-type batteries, and close the battery cover after loading

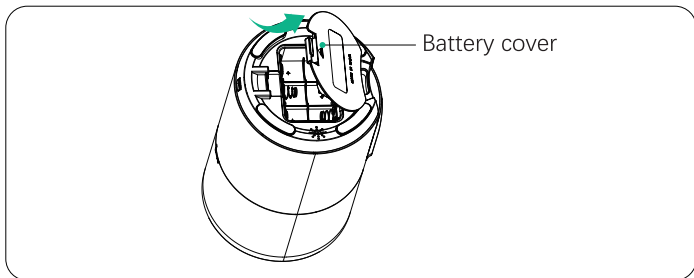

5 Insert power cable

- Insert the Type-C power cable oriented

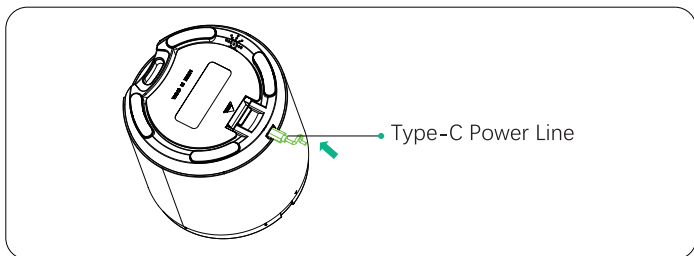

Notes: Although it is not necessary to use both modes at the same time, it is recommended to use both modes in order to prevent the feeder from losing power during any power interruptions

6 Install the bowl

- Put the bowl into the base

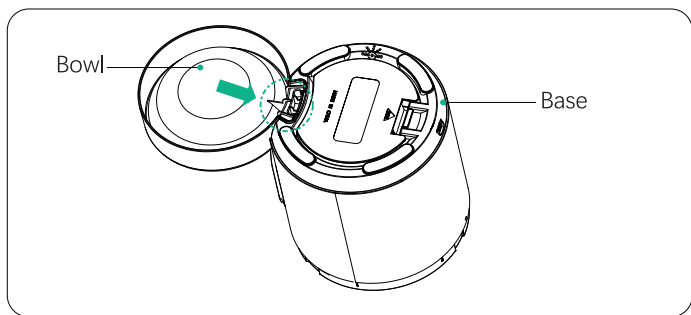

7 Install the food tank

- Follow the pictured arrow, align the ① with the body ②

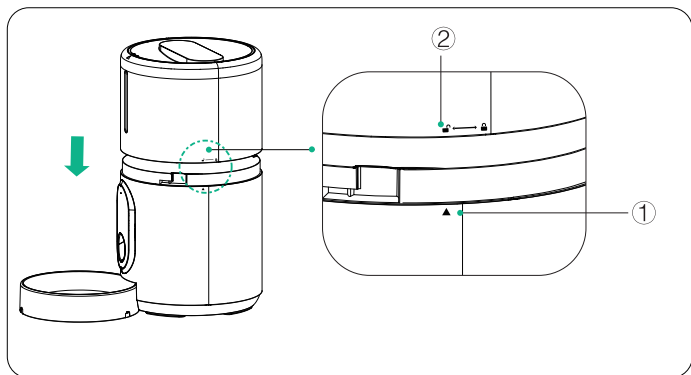

- Install from the top down, and then rotate clockwise.

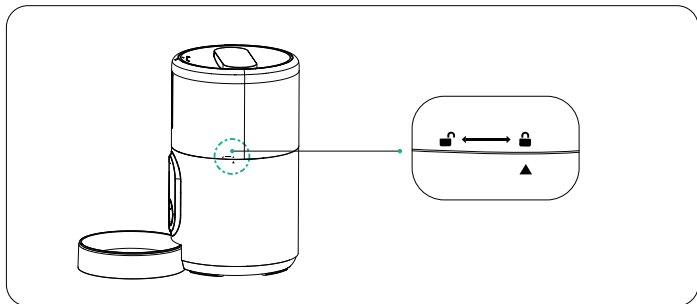

8 Install the cover

- First, align the arrow on the tank to the "unlocked" icon on the lid. Next, turn the lid clockwise to lock the lid. align the arrow on the tank to the "locked" icon on the lid.

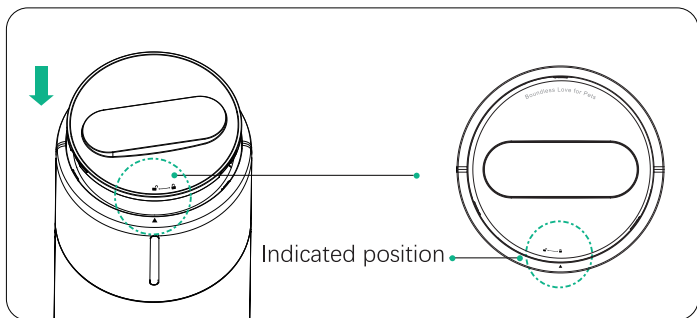

- Load into place, and then twist the knob to lock the lid

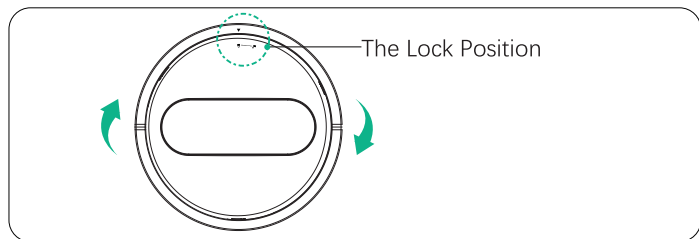

9 Cleaning the food tank

- Rotate the food tank counter-clockwise, then lift it up, and remove the food tank.

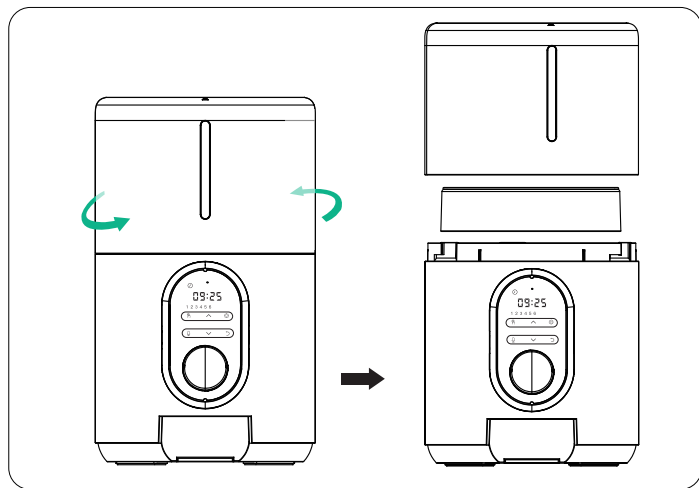

10 Cleaning the rotate plant

- Release Link stopper from the fuselage.

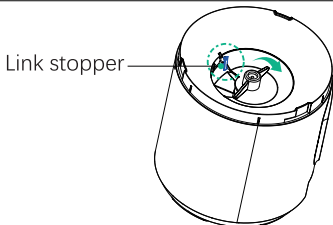

- Turn the turntable counterclockwise

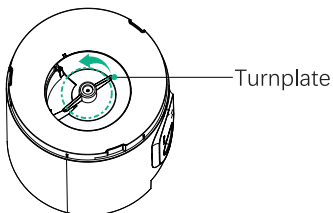

- Lift the turntable up and take out the turntable

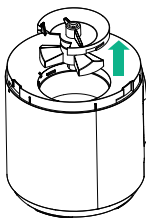

- Install the turnplate, putting the turnplate into the fuselage Feeder base. Align the turntable with the fuselage position indicated, and then place turntable into the fuselage.

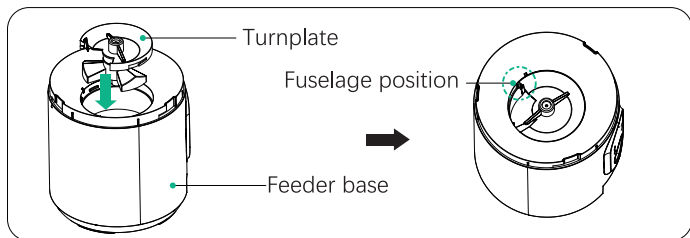

- Put the turntable into the fuselage. Turn the turntable clockwise to the locked position and buckle the baffle into the fuselage slot

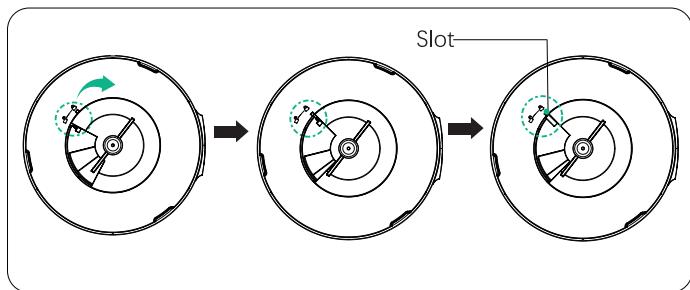



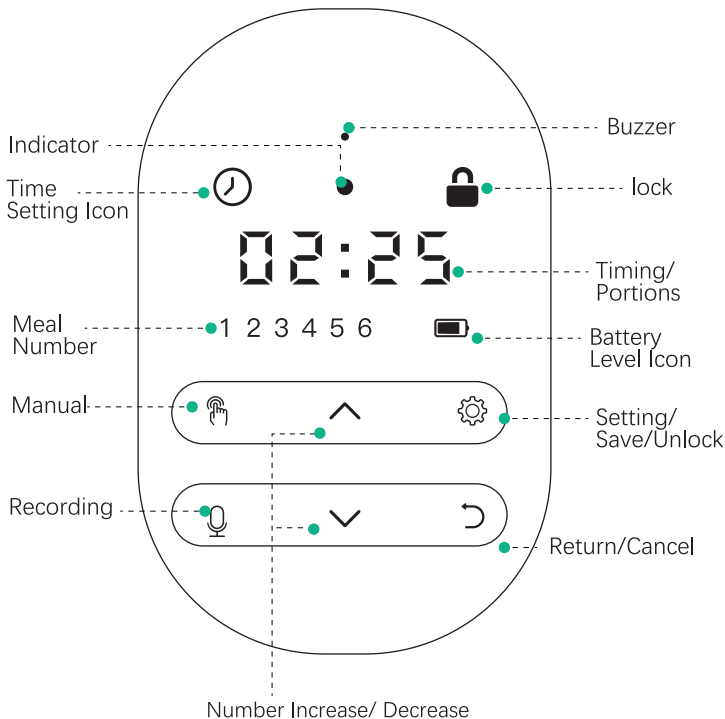



Panel Introduction







Buttons Overview

Note: Will lock automatically after 2mins of inactivity. Hold  for 2s to unlock.

| Button | Description | Operable Mode Function |
|---|----------------------------|--|
|  | Set /Save Unlock button | <ul style="list-style-type: none">• Press to save and move to the next step• Press and hold for 2s to lock/ unlock other buttons and screen |
|  | Return / Cancel button | <ul style="list-style-type: none">• Return to the previous step• Return to interface after setting up |
|  | Number Increase button | <ul style="list-style-type: none">• Press to increase the value• Hold for digit increasing automatically |
|  | Number Decrease button | <ul style="list-style-type: none">• Press to decrease the value• Hold for digit decreasing automatically |
|  | Manual button | <ul style="list-style-type: none">• [Must be Unlocked] Press to feed 1 portion |
|  | Recording button | <ul style="list-style-type: none">• [Must be Unlocked] Hold for 3s and start recording after a beep is heard {max 10s}• Recording saved after a double beep is heard |

Screen Panel Introduction

| Icon | Function of icon |
|--|---|
|  Lock | <ul style="list-style-type: none">• Locks automatically after 2mins of inactivity• Hold  for 2s to unlock |
|  Clock indicator | <p>Flash Indicates:</p> <ul style="list-style-type: none">• Powered by adapter or battery. <p>Note: when flashing, press  to set up/ modify the current time</p> |
| 02:25 Timing 【24-hours format】 | <ul style="list-style-type: none">• Local time |
| 1 2 3 4 5 6 Meal | <ul style="list-style-type: none">• Number of meals |
|  Battery Level | <ul style="list-style-type: none">• Lights up when running on battery power• Turns red to indicate low battery |

Setting Guideline

Step 1 — Setting Current Time

Note: Clock icon flashes when powered as shown in fig.(01).

[If Screen is Locked]

Press  and hold for 2s to unlock screen as shown in fig.(02).



fig.(01)



fig.(02)

TIP: Please note the conversion between 24-hour format and 12-hour format.





Example: 9:00AM = 9:00; 10:00PM = 22:00 More as below

12-hour Clock ↔ 24-hour Clock Comparison Chart

| | | | |
|---------------------|---------------------------------|-----------------------|---------------------------|
| 00:00 (Midnight) | 00:00 (Beginning of the day) | | |
| | | 01:00PM | 13:00 |
| 01:00AM | 01:00 | 02:00PM | 14:00 |
| 02:00AM | 02:00 | 03:00PM | 15:00 |
| 03:00AM | 03:00 | 04:00PM | 16:00 |
| 04:00AM | 04:00 | 05:00PM | 17:00 |
| 05:00AM | 05:00 | 06:00PM | 18:00 |
| 06:00AM | 06:00 | 07:00PM | 19:00 |
| 07:00AM | 07:00 | 08:00PM | 20:00 |
| 08:00AM | 08:00 | 09:00PM | 21:00 |
| 09:00AM | 09:00 | 10:00PM | 22:00 |
| 10:00AM | 10:00 | 11:00PM | 23:00 |
| 11:00AM | 11:00 | 12:00PM (Midnight) | 24:00 (End of the day) |
| 12:00AM (noon) | 12:00 | | |

STEP 1.1— Hour Setting



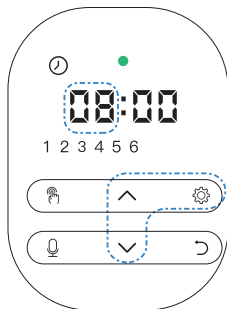

[Must be Unlocked]

Press  to set the “hour” of the time. The two hour digits flash, press / to set the “hour”. Hold /, digits will automatically begin to increase/decrease until the desired time is displayed.



STEP 1.2— Minute Setting

[Must be Unlocked]

After setting hour, press  to move to set the “minute” of the time. press / to set the “minute”. (Press  to modify if needed) Press  to save.

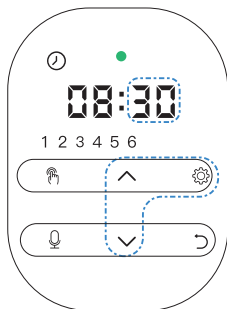







STEP 2— Setting Meal

Step 2.1

Press  then "1" flashes to set up the first meal.



Step 2.2

Press  to set the "hour" of the time, Press / to set the "hour". Press  to move to set the "minute" of the time. Hold /, digits will automatically begin to increase/decrease until the desired time is displayed. Press  to save.



Step 2.3

Press / to set up portion then press  button to save.

Note:

Press  to modify the meal time before saving the portion if needed.



Step 2.4

Press  to move to set other meals. Repeat above step to set up meal time and portion.



STEP 3— Return to Interface

Step 3.1

Press  to return to interface when setting up as shown in fig.(01). (Numbers NOT displayed when portion set to 0 as shown in fig.(02))



fig.(01)



fig.(02)



Step 3.2

Press  to modify local time, feeding time and portion if needed.



STEP 4— Locking & Unlocking

Lock:

Press  to return to interface when setting up, press  for 2s to lock the screen, the lock icon will display.

(**Note:** Locks automatically after 2 min of inactivity)



Unlock:

Press and hold  for 2s to unlock the screen, the lock icon will disappear.



STEP 5— Recording

[Must be Unlocked]

Hold  for 3s and start recording after a beep is heard (max 10s).

Double beep indicates recording is saved.

The recording will be automatically played once after the recording is completed.

Two recordings are played when feeding.

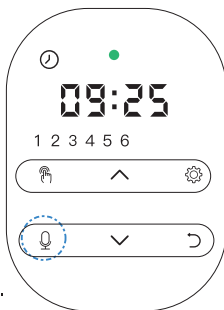

STEP 6— Manual Feed

[Must be Unlocked]

Press  to feed 1 portion.



STEP 7— Feeder Alarm



- When food gets stuck, the indicator turns red.
- When the battery is low, the screen will display low battery and have a flashing sign.



- Replacing the battery or cleaning up your food will cause the indicator to switch to green

STEP 8— Reset to Factory Default

[Must be Unlocked]

Press and hold  and  at the same time for 3s until a beep is heard.



FAQs

Q: Why the motor runs but no food comes out?

A: Please make sure the removable parts installed into the feeder correctly. For more information, please refer page 10-11.

Q: Why the motor runs reversely?

A: When the food gets stuck, the motor will run reversely to solve the food stuck problem.

Q: Why the feeder shows low battery but the battery is new?

A: Some rechargeable batteries have low voltages, and the feeder may give false message. Please ignore or replace ordinary non-rechargeable batteries.

Any more questions, please email our support team:



support@wopet.com



Scan the QR code to set up the feeder

FCC Warnings

- Changes or modifications to this unit not expressly approved. Non-compliance could void the user's authority to operate the equipment.

Notes:

This equipment has been tested and found to comply with the limits for a Class B digital device, pursuant to Part 15 of the FCC Rules. These limits are designed to provide reasonable protection against harmful interference in a residential installation.

This equipment generates, uses and can radiate radio frequency energy and, if not installed and used in accordance with the instructions, may cause harmful interference to radio communications. However, there is no guarantee that interference will not occur in a particular installation. If this equipment does cause harmful interference to radio or television reception, which can be determined by turning the equipment off and on, the user is encouraged to try to correct the interference by one or more of the following Measures:

- Reorient or relocate the receiving antenna.
- Increase the distance between the equipment and receiver.
- Connect the equipment into an outlet on a different circuit from that to which the receiver is connected.
- Consult the dealer or an experienced radio/TV technician for help. Shielded interface cables must be used with the equipment in order to comply with the limits for a digital device pursuant to Sub part B of Part 15 of FCC Rules. Specifications and designs are subject to change without any notice or obligation on the part of the manufacturer.

Warranty Information

1 NON-TRANSFERRABLE LIMITED WARRANTY

①.To provide customers with quality shopping and user experience, we guarantee to replace or issue a refund or provide acceptable solutions to any defective products (as customer prefer) from the date of purchase to 2 years

②.Proof of purchase must be provided (order number or receipt) when making a claim to our customer support center.

③.Warranty registration may be requested within a month since the date of purchase,by sending your order number to the mailbox: support@wopet.com

- ④. The warranty is not transferable. We only provide warranty services to buyers who purchased from our Amazon store and WOpet official website store and possess the purchase proof, and not to any other purchaser or subsequent owner. Price matching policy is not applicable. No price difference refund.
- ⑤. Sellers are the responsible party, Amazon allows different sellers to sell the same product, so please confirm the seller by checking the order details before contacting us.

2 What is Covered

- Received defective or used (proof needed) products.
- Received with missing parts.
- Defective item under proper use.

3 What is not Covered

- Purchase from non-amazon channels/non-WOpet official website store/other physical stores
- Gift without proof of purchase;
- Tampering/abnormal use/accidental damage.
- Replacements and parts.
- Installation fee/labor fee.

4 Making a claim

If you have any problems when using our products, you can choose any of the methods to reach out of us.

- Email: support@wopet.com
- 30 days free Return & Replacement
- Standard Warranty: 1-Year product Warranty
- 2-Year Warranty Application: Please scan the QR code below to finish the registration form on our official website to get 2-Year in total warranty.

Note:

Please finish the form within 30 days after you received the items.



Have a Question For the Seller?

1. Find your order

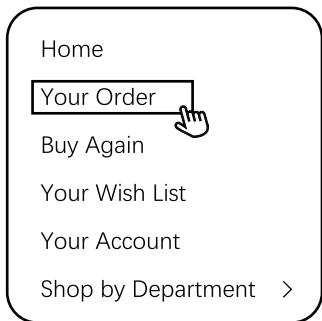

2. Click "View order details"



3. Click the Seller name



4. Click "Ask a question"



- Gifted parts, replacements, consumable products are not covered by the 2-year warranty
- Manufactures' warranties may not apply in all cases, depending on factors such as use of the product, where the product was purchased, or who you purchase the product from.
- Please review the warranty carefully, and contact the manufacture if you have any questions.



wopet

Boundless Love for Pets